

ALUMINUM ENTRANCE DOORS SECTION



ALUMINUM DOORS

PART 1 GENERAL

1.1 SECTION INCLUDES

- A. Aluminum doors.

1.2 REFERENCES

- A. ASTM International (ASTM):
 1. ASTM B 221 - Standard Specification for Aluminum and Aluminum-Alloy Extruded Bars, Rods, Wire, Profiles, and Tubes.
 2. ASTM E 283 - Test Method for Determining the Rate of Air Leakage Through Exterior Windows, Curtain Walls, and Doors under Specified Pressure Differences across the Specimen.
 3. ASTM E 330 - Standard Test Method for Structural Performance of Exterior Windows, Doors, Skylights and Curtain Walls by Uniform Static Air Pressure Difference.

1.3 SUBMITTALS

- A. Submit under provisions of Section 01 30 00 - Administrative Requirements.
- B. Product Data: Manufacturer's data sheets on each product to be used, including:
 1. Preparation instructions and recommendations.
 2. Storage and handling requirements and recommendations.
 3. Installation methods.
- C. Shop Drawings: Configuration and details for installation, maintenance and operation.
- D. Selection Samples: For each finish product specified, two complete sets of color chips representing manufacturer's full range of available colors and patterns.
- E. Verification Samples: For each finish product specified, two samples, minimum size 6 inches (150 mm) square representing actual product, color, and patterns.

1.4 QUALITY ASSURANCE

- A. Manufacturer Qualifications: Minimum 5 year experience manufacturing similar products.
- B. Installer Qualifications: Minimum 2 year experience installing similar products.
- C. Mock-Up: Provide a mock-up for evaluation of surface preparation techniques and application workmanship.
 1. Finish areas designated by Architect.
 2. Do not proceed with remaining work until workmanship is approved by Architect.
 3. Refinish mock-up area as required to produce acceptable work.

1.5 PRE-INSTALLATION MEETINGS

ALUM. DOORS - 1

- A. Convene minimum two weeks prior to starting work of this section.

1.6 DELIVERY, STORAGE, AND HANDLING

- A. Deliver and store products in manufacturer's unopened packaging bearing the brand name and manufacturer's identification until ready for installation.
- B. Handling: Handle materials to avoid damage.

1.7 PROJECT CONDITIONS

- A. Maintain environmental conditions (temperature, humidity, and ventilation) within limits recommended by manufacturer for optimum results. Do not install products under environmental conditions outside manufacturer's recommended limits.

1.8 SEQUENCING

- A. Ensure that products of this section are supplied to affected trades in time to prevent interruption of construction progress.

PART 2 PRODUCTS

2.1 MANUFACTURERS

- A. Acceptable Manufacturer: PRL Glass Systems, Inc., which is located at: 13644 Nelson Ave.; City of Industry, CA 91746; Toll Free Tel: 800-433-7044; Fax: 626-968-9256; Email: request; Web: prlglass.com
- B. Substitutions: Not permitted.
- C. Requests for substitutions will be considered in accordance with provisions of Section 01 60 00 - Product Requirements.

2.2 DOORS

- A. Narrow Stile:
 - 1. 2 inches (51 mm) stile and rail.
 - 2. Strong reinforced corner construction permits use in heavy traffic areas of commercial applications.
 - 3. Narrow stile Center pivot single acting.
 - 4. Offset pivot single acting.
 - 5. Butt hinge single acting.
- B. Medium Stile:
 - 1. 3-1/2 inches stile with 3-1/4 inches rail.
 - 2. Medium stile Center pivot double acting
 - 3. Offset pivot single acting
 - 4. Butt hinge single acting.
 - 5. A top performance door with a medium stile that accommodates standard and custom hardware and panic devices for commercial and institutional applications.
 - 6. Strong reinforced corner construction increases size limitation to a 4'-0" door width 9'0" maximum door height.
- C. Wide Stile:
 - 1. 5 inches (127 mm) stile with 5-1/8 inches (130 mm) rail.
 - 2. Wide stile Center pivot double acting
 - 3. Offset pivot single acting
 - 4. Butt hinge single acting.

ALUM. DOORS - 2

5. A monumental type door with strength and stability for heavy use. The wide stiles will accommodate most all standard and unusual hardware designs and operation requirements. Size limitations are 4'-0" door width and 9'0" maximum door height.
- D. Custom Door:
1. Offer style and performance with unlimited adaptability to specific design requirements with combinations of stiles, top/bottom rails and intermediate vertical/horizontal muntins, will receive most standard pivot/hinges, lock and security hardware. Strong reinforced corner construction permits its use on a wide variety of applications. Some limitations apply please consult PRL Aluminum for details.
- E. Accessories:
1. ADA Bottom Rail: 10-1/2 inches (267 mm) high.
 2. Threshold: 4 inches (102 mm) extruded aluminum
 - a. Finish: Mill.
 - b. Finish: Clear anodized.
 - c. Finish: Bronze.
 3. Threshold: 5 inches (127 mm) extruded aluminum
 - a. Finish: Mill.
 - b. Finish: Clear anodized.
 - c. Finish: Bronze.
 4. Threshold: 5 inches (127 mm) extruded aluminum with bulb seal.
 - a. Finish: Mill.
 - b. Finish: Clear anodized.
 - c. Finish: Bronze.
 5. Threshold: 7 inches (178 mm) extruded aluminum.
 - a. Finish: Mill.
 - b. Finish: Clear anodized.
 - c. Finish: Bronze.
- F. Hardware:
1. Refer to Section 08 71 53 - Security Door Hardware.

PART 3 EXECUTION

3.1 EXAMINATION

- A. Do not begin installation until substrates have been properly prepared.
- B. If substrate preparation is the responsibility of another installer, notify Architect of unsatisfactory preparation before proceeding.

3.2 PREPARATION

- A. Clean surfaces thoroughly prior to installation.
- B. Prepare surfaces using the methods recommended by the manufacturer for achieving the best result for the substrate under the project conditions.

3.3 INSTALLATION

- A. Install in accordance with manufacturer's instructions.

3.4 FIELD QUALITY CONTROL

- A. All joints between metal and masonry shall be fully caulked and field tested to resist water leakage with provisions taken to drain infiltrated water.

3.5 PROTECTION

- A. Protect installed products until completion of project.
- B. Touch-up, repair or replace damaged products before Substantial Completion.

END OF SECTION

All Entrance Doors are available in single acting offset pivot, butt hinge or center pivot operation. High bottom rails may be adapted to all sizes and to meet local codes. All doors are produced to specific size requirements in widths and heights within limits of each specific door.

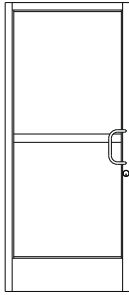

Narrow stile

Narrow stile Center pivot single acting, Offset pivot single acting, Butt hinge single acting. An industry standard in style and performance. Narrow stiles and rails provide narrow sight lines yet receives most standard hardware designs. Strong reinforced corner construction permits use in heavy traffic areas of commercial applications.

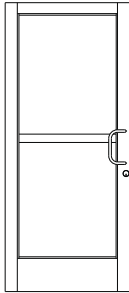

Medium stile

Medium stile Center pivot double acting, Offset pivot single acting, Butt hinge single acting. A top performance door with a medium stile that accommodates standard and custom hardware and panic devices for commercial and institutional applications. Strong reinforced corner construction increases size limitation to a 4'-0" door width 9'0" maximum door height.

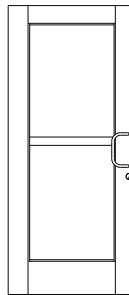

Wide stile

Wide stile Center pivot double acting, Offset pivot single acting, Butt hinge single acting. A monumental type door with strength and stability for heavy use. The wide stiles will accommodate most all standard and unusual hardware designs and operation requirements. Size limitations are 4'-0" door width and 9'0" maximum door height.

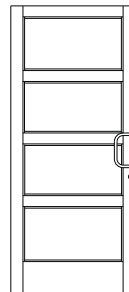

Custom Doors

Offer style and performance with unlimited adaptability to specific design requirements with combinations of stiles, top/bottom rails and intermediate vertical/horizontal muntins, will receive most standard pivot/hinges, lock and security hardware. Strong reinforced corner construction permits its use on a wide variety of applications. Some limitations apply please consult PRL Aluminum for details.

CENTER HUNG

Standard doors hardware includes std lock/cylinder on single doors and pairs active leaf, header/threshold bolt for pairs inactive leaf with push bars BTB.

All doors are prepared to receive side load arm for concealed closers (pivots are not included).

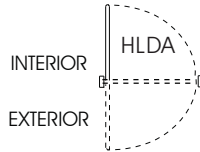
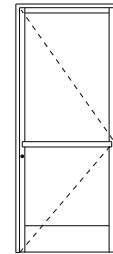
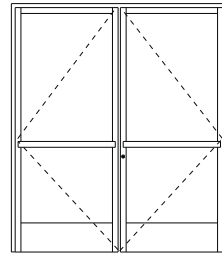
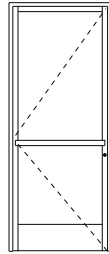

HINGED LEFT
DOUBLE ACTING

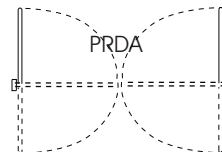

PAIR OF DOUBLE ACTING



HINGED RIGHT
DOUBLE ACTING

OFFSET HUNG

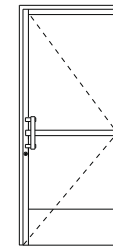
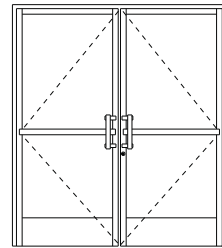
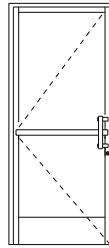

HINGED LEFT
SWING OUT

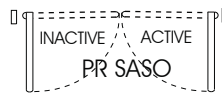

PAIR OF SINGLE ACTING
SWING IN



HINGED RIGHT
SWING OUT

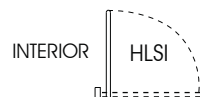
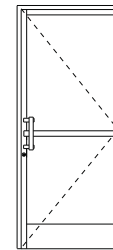
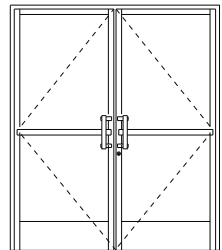
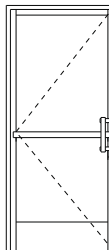

HINGED LEFT
SWING IN

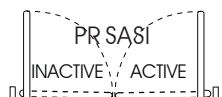

PAIR OF SINGLE ACTING
SWING OUT



HINGED RIGHT
SWING IN

NARROW STYLE
 2" VERTICAL STILE

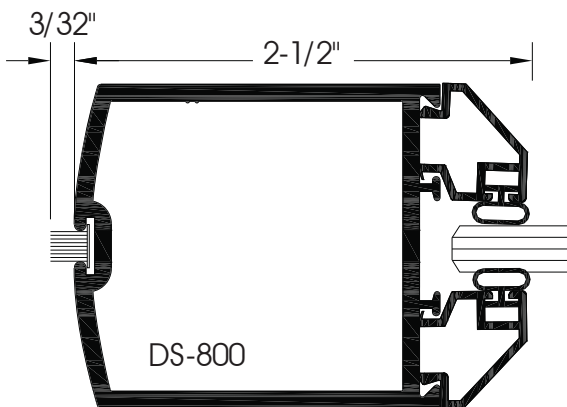

CENTER HUNG DOOR
 1/4" BEVEL GLASS STOP

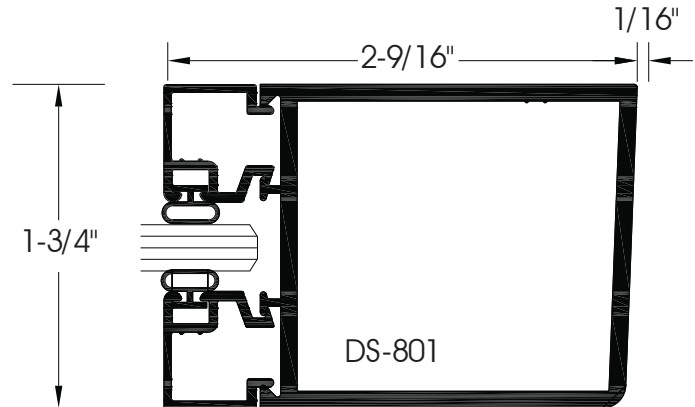

DRGS-14
OFFSET HUNG DOOR
 1/4" SQUARE GLASS STOP

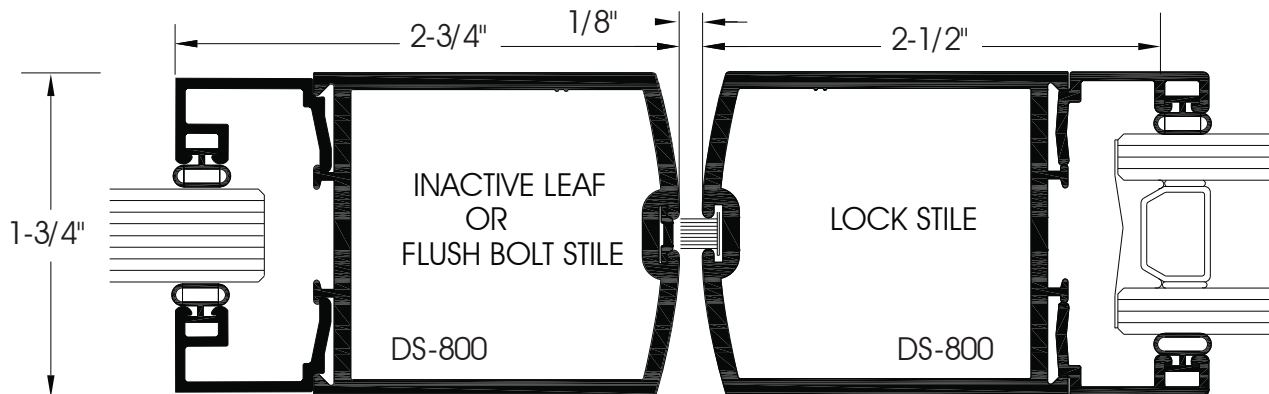

DRGS-12
CENTER HUNG DOORS
 1/2" GLASS STOP

MEETING STILES

DRGS-1
CENTER HUNG DOORS
 1" GLASS STOP



MATERIAL: 6063-T5 aluminum alloy.

FINISH: Standard finishes are mill, clear and bronze anodized. All others are special order.

NOTES: Storefronts are available in quick set or screw race, please consult PRL aluminum for details

ALUM. DOORS - 7

ENTRANCE DOORS
 1/4"-1" GLASS STOP
 FULL SCALE



NARROW STYLE
 2" RAIL

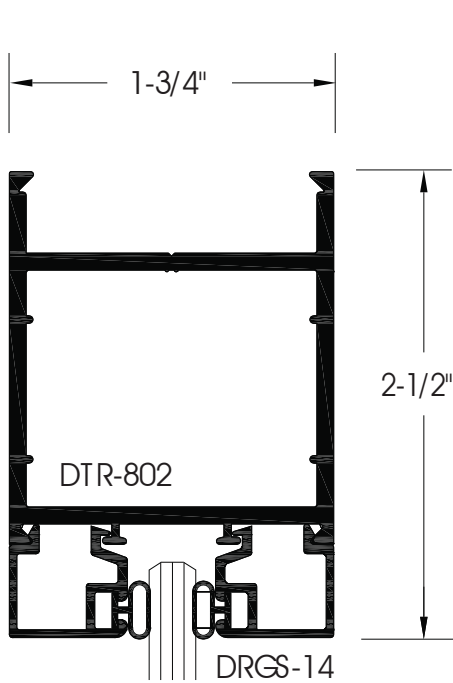

TOP/BOTTOM
 DOOR RAIL
 1/4" GLASS STOP

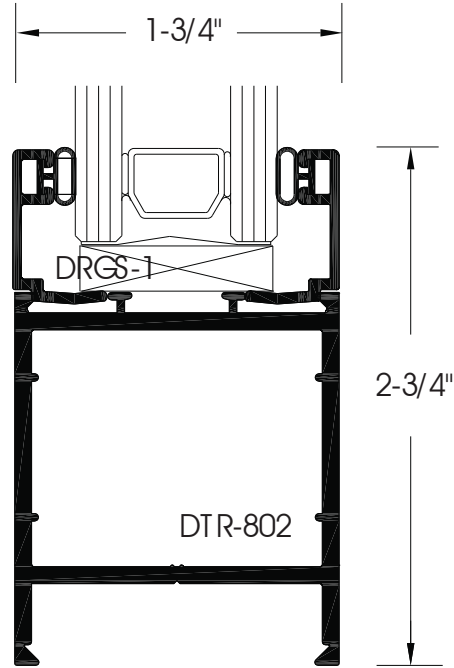

TOP/BOTTOM
 DOOR RAIL
 1" GLASS STOP

FINISH: Standard finishes are mill, clear and bronze anodized. All others are special order.
NOTES: Storefronts are available in quick set or screw race, please consult PRL aluminum for details

ALUM. DOORS - 8
 14760 Don Julian Rd.
 Industry, CA 91746

ph: (877) 775-2586
 fx: (877) 274-8800

www.prlaluminum.com
sales@prlaluminum.com

ENTRANCE DOORS
1/2"-1" GLASS STOP
FULL SCALE



MEDIUM STYLE
 3 1/2" VERTICAL STILE

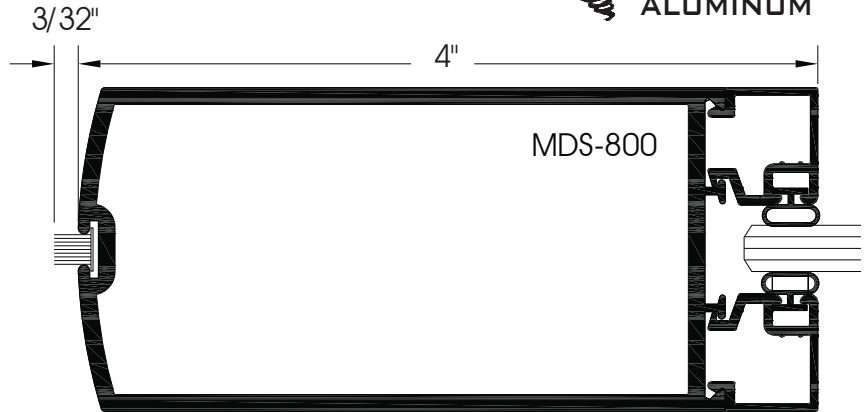

CENTER HUNG DOOR STILE
 1/4" GLASS STOP

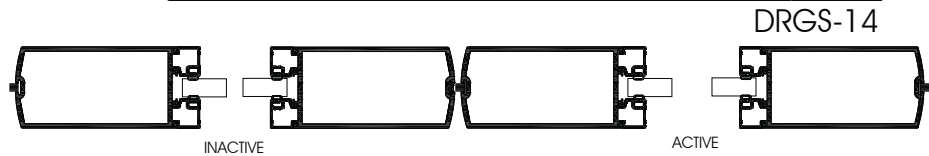

INACTIVE LEAF DOOR STILE
 1" GLASS STOP

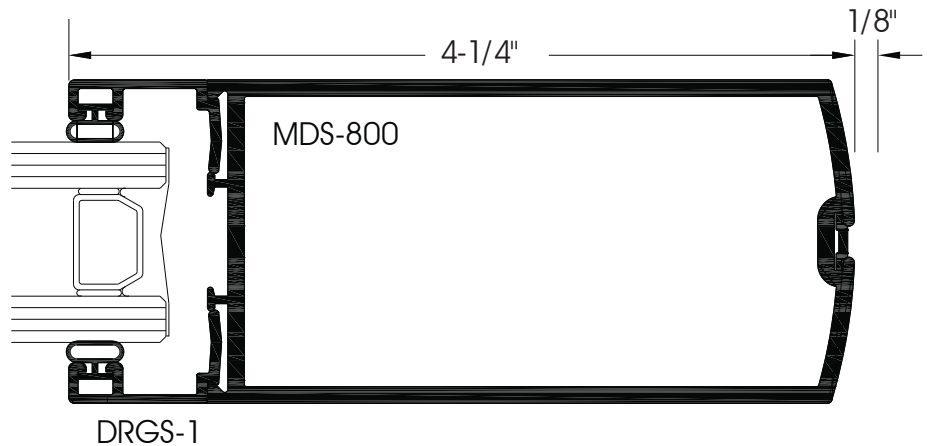

OFFSET HUNG DOOR STILE
 1/4" GLASS STOP

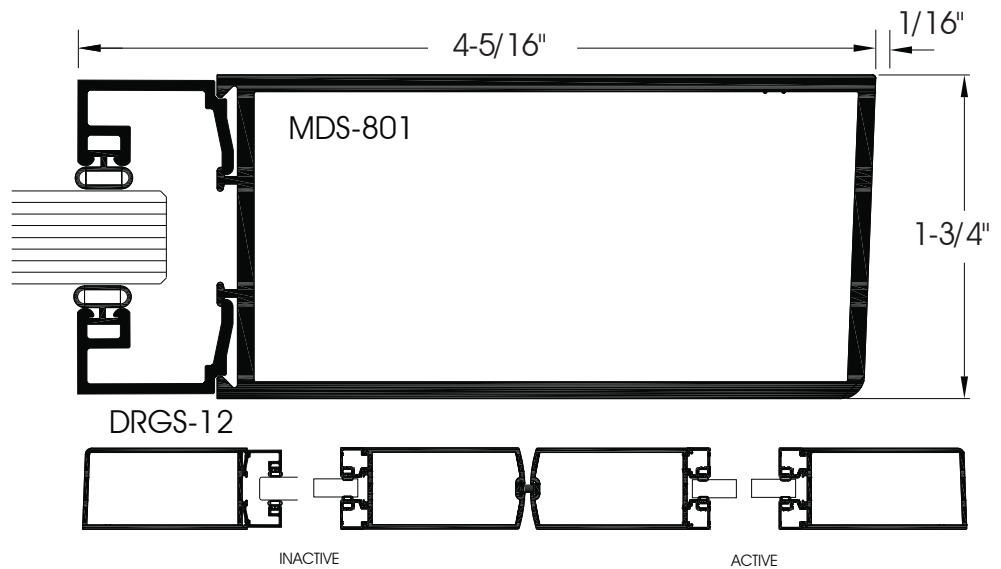

MATERIAL: 6063-T5 aluminum alloy.

FINISH: Standard finishes are mill, clear and bronze anodized. All others are special order.

NOTES: Storefronts are available in quick set or screw race, please consult PRL aluminum for details

ALUM. DOORS - 9

14760 Don Julian Rd.
 Industry, CA 91746

ph: (877) 775-2586
 fx: (877) 274-8800

www.prlaluminum.com
 sales@prlaluminum.com

ENTRANCE DOORS
 1/4"-1" GLASS STOP
 FULL SCALE



MEDIUM STYLE s
 3 1/4" RAIL

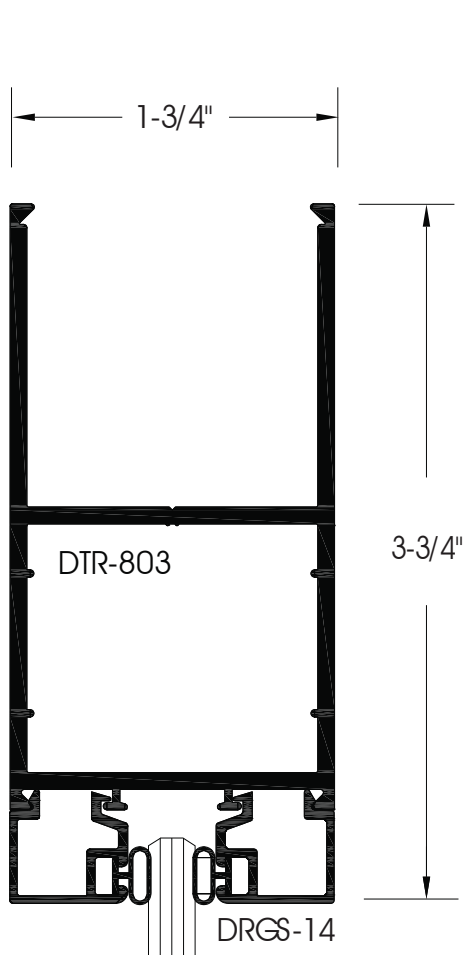

TOP/BOTTOM
 DOOR RAIL
 1/4" GLASS STOP

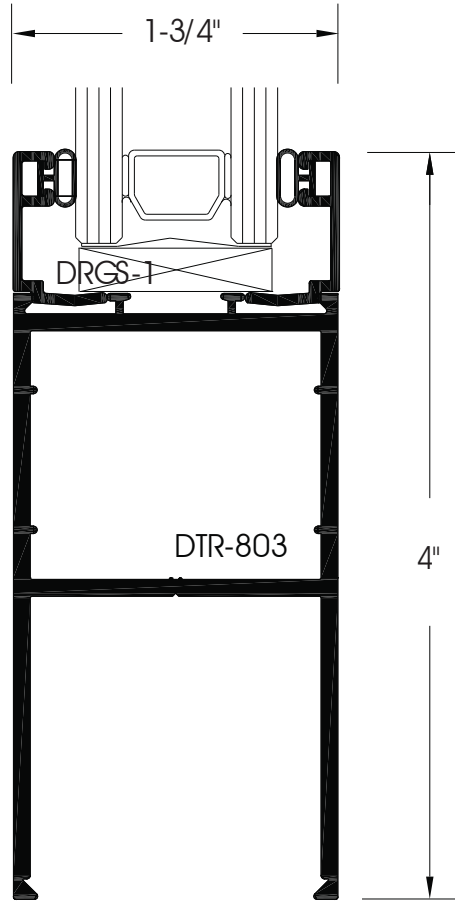

TOP/BOTTOM
 DOOR RAIL
 1" GLASS STOP

MATERIAL: 6063-T5 aluminum alloy.

FINISH: Standard finishes are mill, clear and bronze anodized. All others are special order.

NOTES: Storefronts are available in quick set or screw race, please consult PRL aluminum for details

ALUM. DOORS - 10

14760 Don Julian Rd.
 Industry, CA 91746

ph: (877) 775-2586
 fx: (877) 274-8800

www.prlaluminum.com
 sales@prlaluminum.com

ENTRANCE DOORS
1/2"-1" GLASS STOP
FULL SCALE

WIDE STYLE
 5" VERTICAL STILE

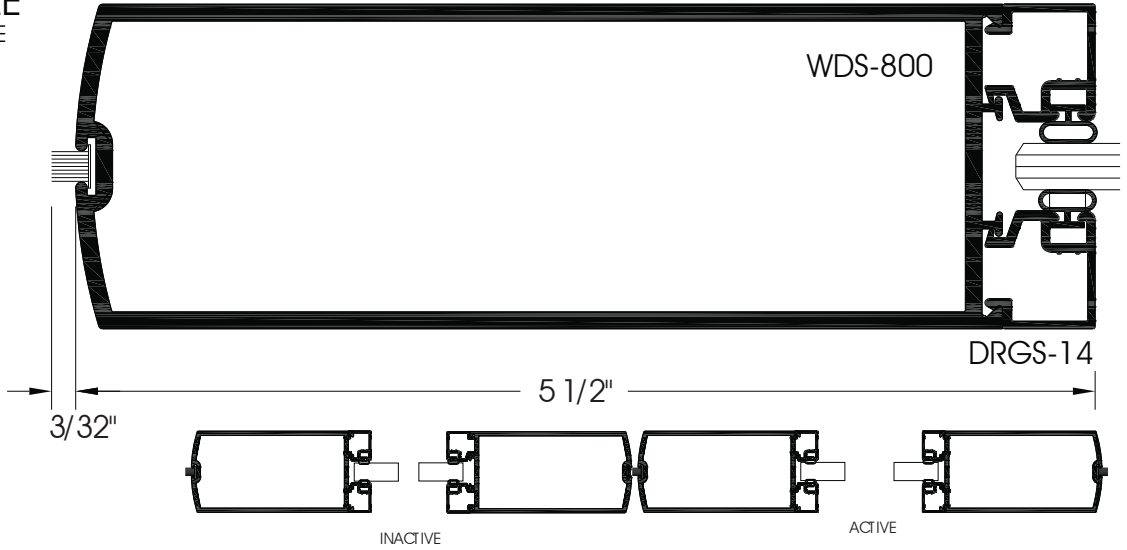

CENTER HUNG
DOOR STILE
 1/4" GLASS STOP

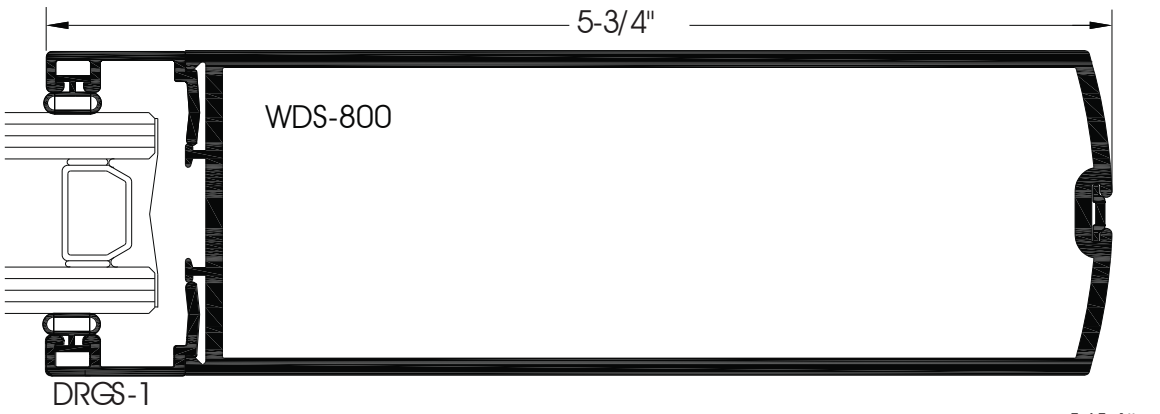

INACTIVE LEAF
DOOR STILE
 1" GLASS STOP

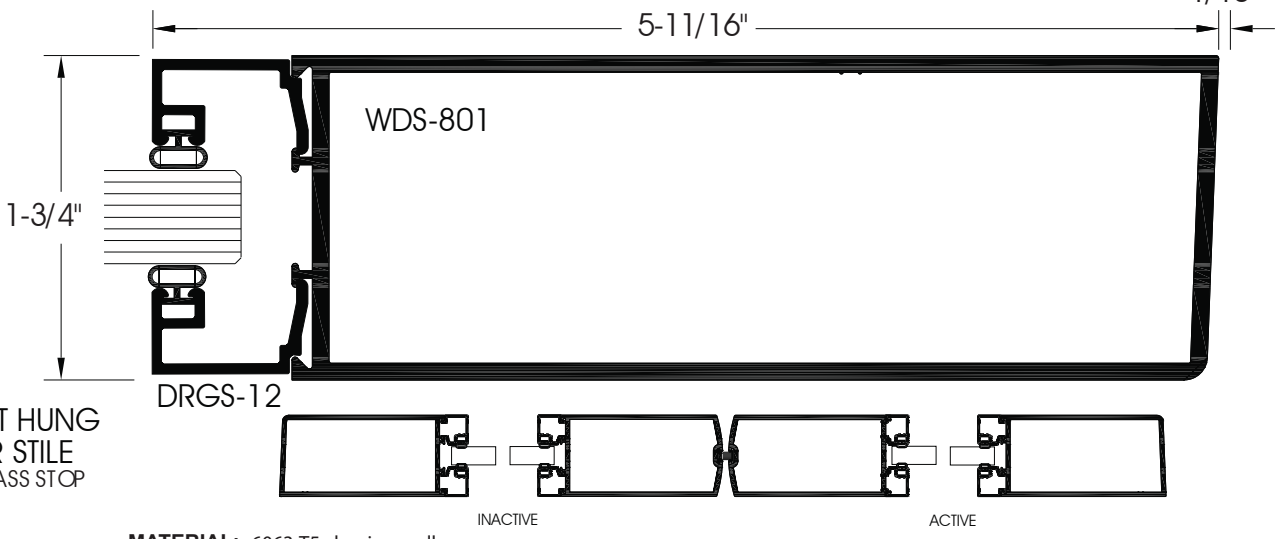

OFFSET HUNG
DOOR STILE
 1/2" GLASS STOP

MATERIAL: 6063-T5 aluminum alloy.
FINISH: Standard finishes are mill, clear and bronze anodized. All others are special order.
NOTES: Storefronts are available in quick set or screw race, please consult PRL aluminum for details

ALUM. DOORS - 11

ph: (877) 775-2586
 fx: (877) 274-8800

14760 Don Julian Rd.
 Industry, CA 91746

www.prlaluminum.com
 sales@prlaluminum.com

ENTRANCE DOORS
1/4"-1" GLASS STOP
FULL SCALE



WIDE STYLE

5 1/8" RAIL

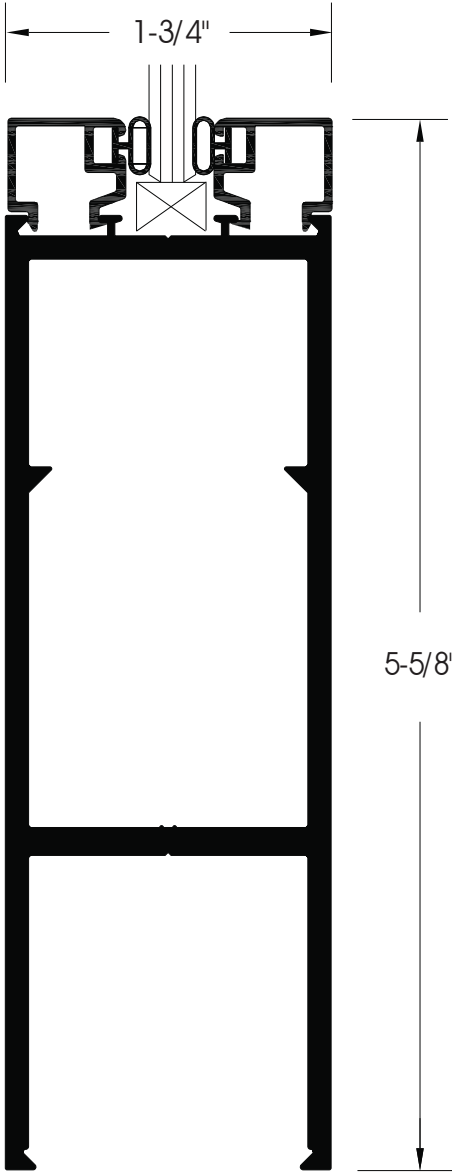

TOP/BOTTOM
 DOOR RAIL
 1/4" GLASS STOP

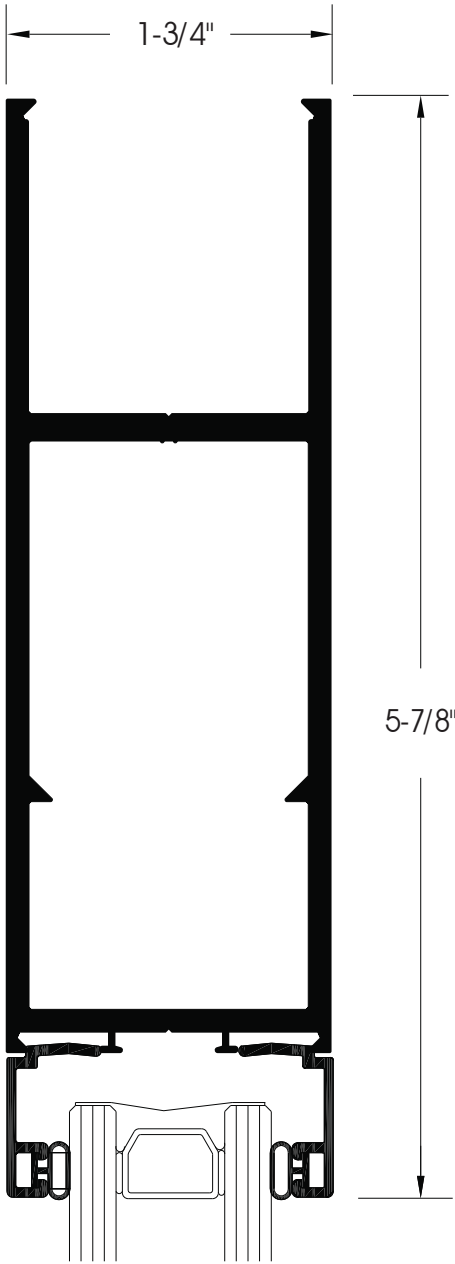

TOP/BOTTOM
 DOOR RAIL
 1" GLASS STOP

MATERIAL: 6063-T5 aluminum alloy.
FINISH: Standard finishes are mill, clear and bronze anodized. All others are special order.
NOTES: Storefronts are available in quick set or screw race, please consult PRL aluminum for details

ALUM. DOORS - 12

ph: (877) 775-2586
 fx: (877) 274-8800

14760 Don Julian Rd.
 Industry, CA 91746

www.prlaluminum.com
 sales@prlaluminum.com

4" THRESHOLD

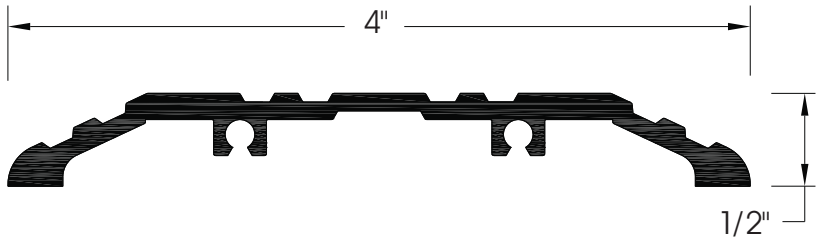

5" THRESHOLD

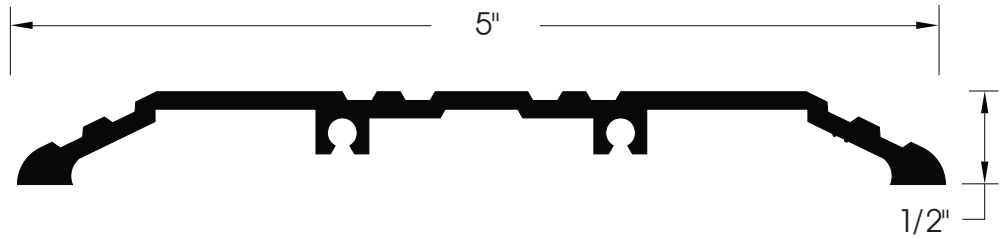

5" THRESHOLD

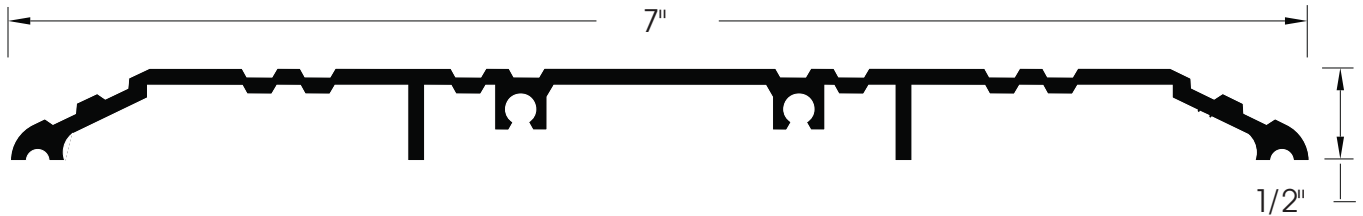
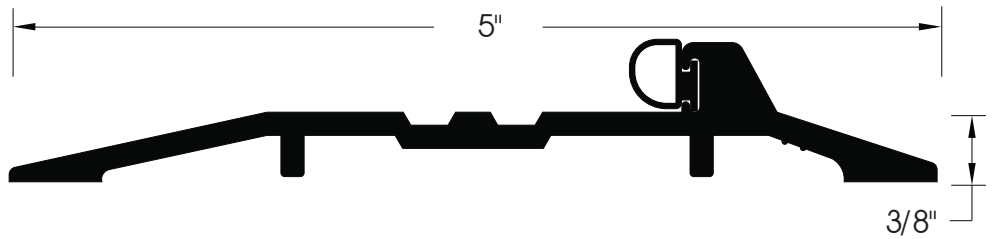

7" THRESHOLD

MATERIAL: 6063-T5 aluminum alloy.

FINISH: Standard finishes are mill, clear and bronze anodized. All others are special order.

NOTES: Storefronts are available in quick set or screw race, please consult PRL aluminum for details

ALUM. DOORS - 13

ENTRANCE DOORS
1/4"-1" GLASS STOP
FULL SCALE



10" BOTTOM RAIL



TYPICAL APPLICATION

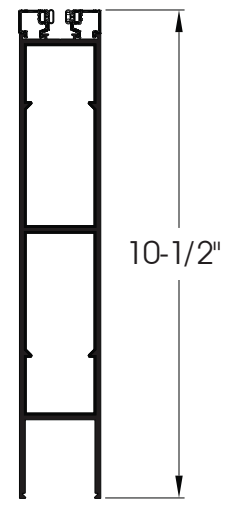
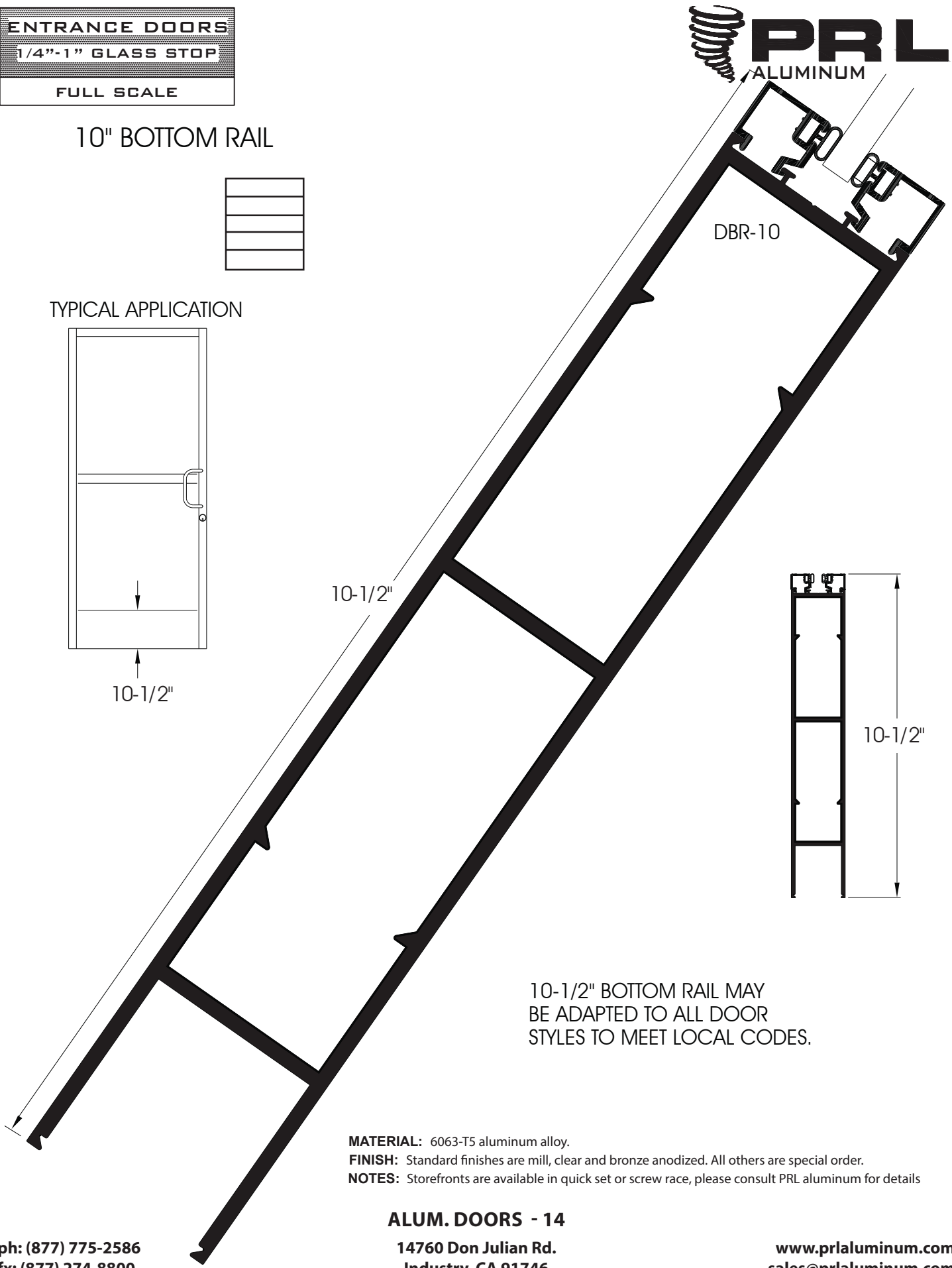
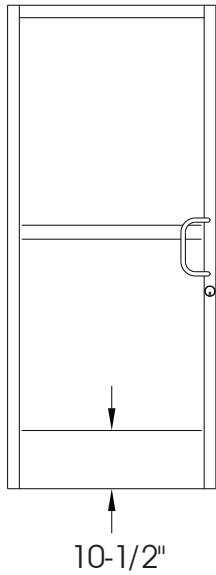

10-1/2" BOTTOM RAIL MAY BE ADAPTED TO ALL DOOR STYLES TO MEET LOCAL CODES.

MATERIAL: 6063-T5 aluminum alloy.
FINISH: Standard finishes are mill, clear and bronze anodized. All others are special order.
NOTES: Storefronts are available in quick set or screw race, please consult PRL aluminum for details

ph: (877) 775-2586
 fx: (877) 274-8800

ALUM. DOORS - 14
 14760 Don Julian Rd.
 Industry, CA 91746

www.prlaluminum.com
sales@prlaluminum.com

HORIZONTAL MUNTIN

3 1/4" MUNTIN

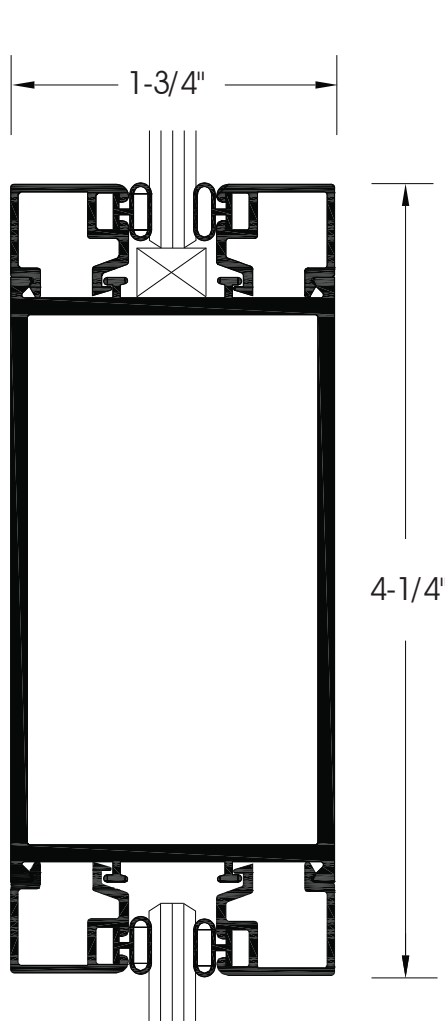

HORIZONTAL
 DOOR MUNTIN
 1/4" GLASS STOP

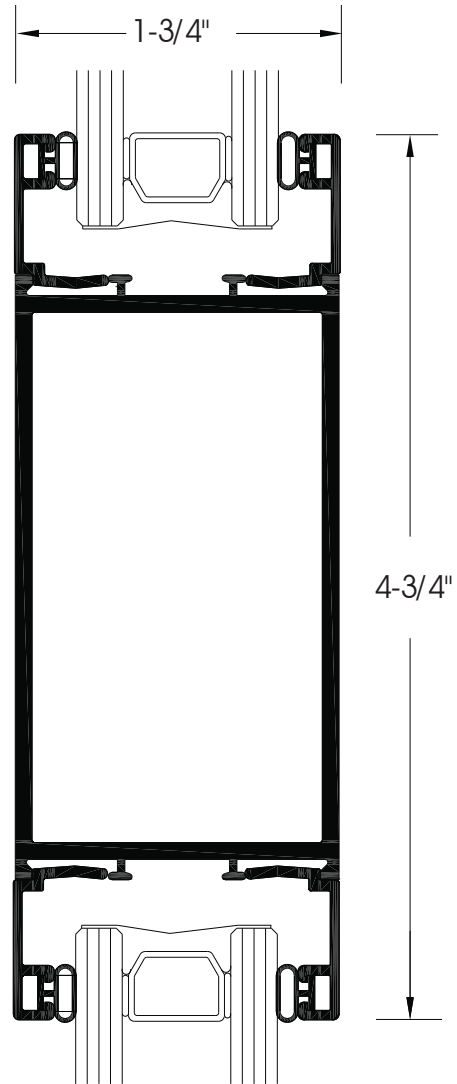

HORIZONTAL
 DOOR MUNTIN
 1" GLASS STOP

MATERIAL: 6063-T5 aluminum alloy.

FINISH: Standard finishes are mill, clear and bronze anodized. All others are special order.

NOTES: Storefronts are available in quick set or screw race, please consult PRL aluminum for details

ALUM. DOORS - 15

14760 Don Julian Rd.
 Industry, CA 91746

ph: (877) 775-2586
 fx: (877) 274-8800

www.prlaluminum.com
 sales@prlaluminum.com

HORIZONTAL MUNTIN
 2" MUNTIN

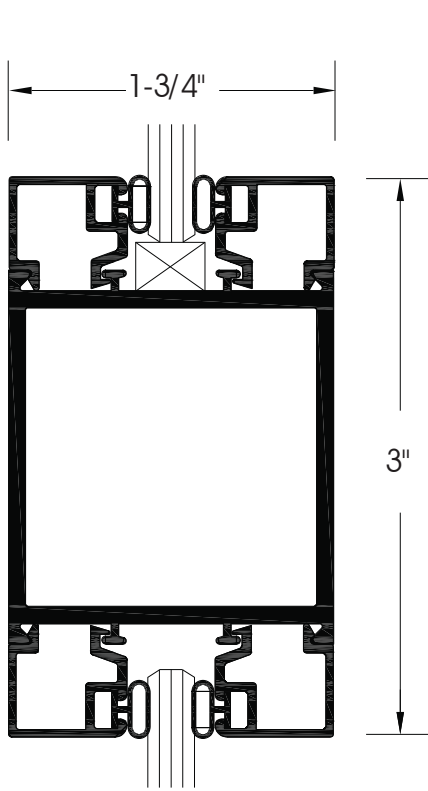

HORIZONTAL
 DOOR MUNTIN
 1/4" GLASS STOP

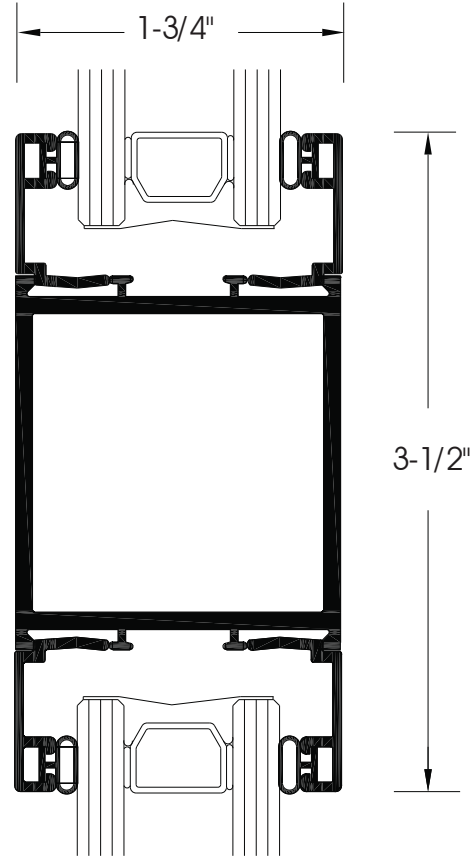

HORIZONTAL
 DOOR MUNTIN
 1" GLASS STOP

MATERIAL: 6063-T5 aluminum alloy.

FINISH: Standard finishes are mill, clear and bronze anodized. All others are special order.

NOTES: Storefronts are available in quick set or screw race, please consult PRL aluminum for details

ALUM. DOORS - 16

ph: (877) 775-2586
 fx: (877) 274-8800

14760 Don Julian Rd.
 Industry, CA 91746

www.prlaluminum.com
 sales@prlaluminum.com

ENTRANCE DOORS
 1/2"-1" GLASS STOP
 FULL SCALE

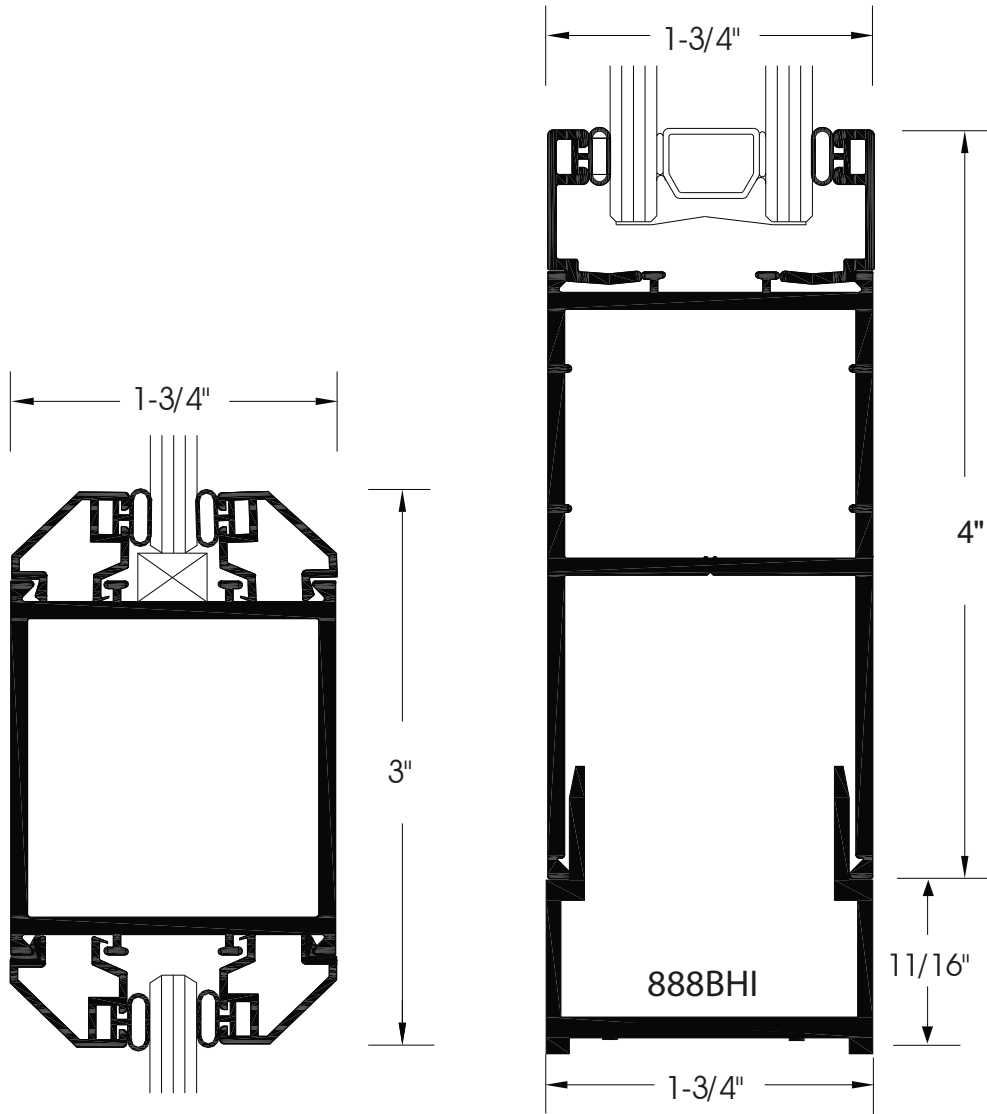

HORIZONTAL
 DOOR MUNTIN
 + 1/4" BEVEL GLASS STOP

DOOR RAIL
 +BULK HEAD INSERT

MATERIAL: 6063-T5 aluminum alloy.

FINISH: Standard finishes are mill, clear and bronze anodized. All others are special order.

NOTES: Storefronts are available in quick set or screw race, please consult PRL aluminum for details

ALUM. DOORS - 17

ph: (877) 775-2586
 fx: (877) 274-8800

14760 Don Julian Rd.
 Industry, CA 91746

www.prlaluminum.com
 sales@prlaluminum.com

